

Article number: 12317000100100
Description: KLEE-coil 317 000 100.100
M10 Unhardened steel slotted pin

Measures

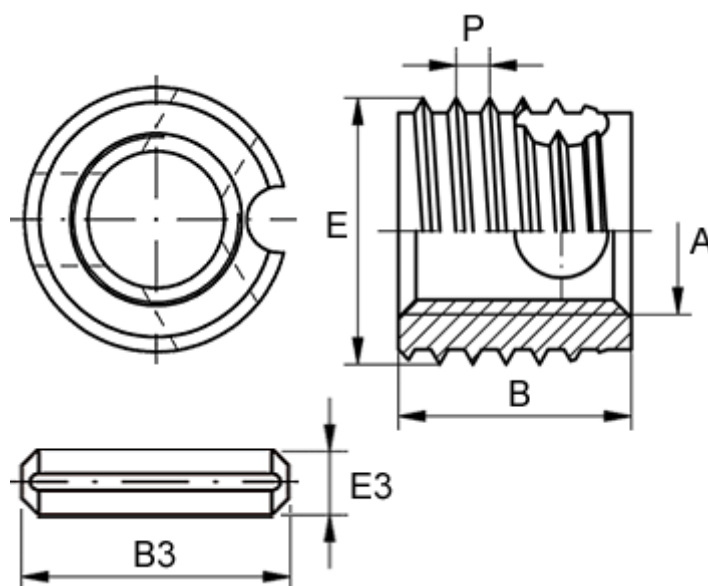

Female thread A	= M10
Length B	= 10
Male thread E	= 14.0
Min hole depth blind hole	= 13
Slotted pin B3	= 6
Slotted pin E3	= 2
Thread pitch P	= 1.50
Type	= 317 000 100 ...